





i Als „Industrieniete“ oder „DIN-Niete“ bezeichnet man die klassischen **einteiligen Verbindungselemente**, deren Verarbeitung **beidseitig** des Bauteils erfolgt.

Die Verbindung wird durch Umformung des Nietschaftes mittels axialem Druck auf das Schaftende ausgebildet. Die Produktion der in der Übersicht auf ► **Seite 129** aufgeführten Niet-Typen ist auf Anfrage grundsätzlich in den Werkstoffen Aluminium, Stahl, Kupfer, Messing, zum Teil auch in Edelstahl A2 und A4 möglich.

Die VVG Befestigungstechnik führt ein sehr umfangreiches Lager.

Sprechen Sie unser Vertriebsteam betreffend aktueller Tagespreise und Verfügbarkeiten, sowie Produktions- und Verarbeitungsmöglichkeiten an!



Beraterfinder

Es werden bei Industrieniete grundsätzlich drei verschiedene Formen unterschieden:

Vollniete - Niete mit massivem Schaft

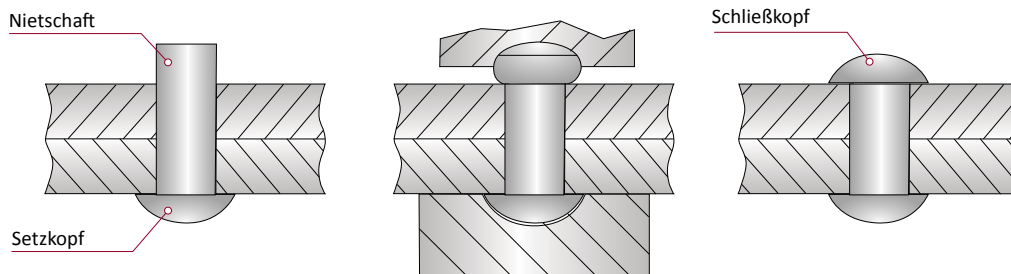

Halbhohnniete - Niete mit teilweiser Schaftbohrung

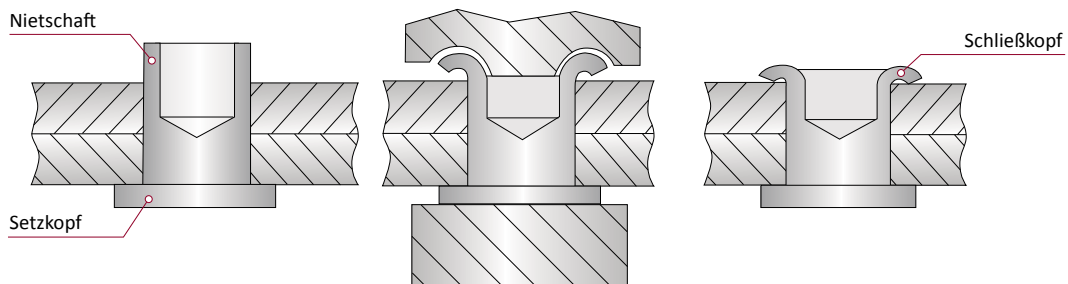

Hohl- oder Rohrniete - Niete mit durchgängiger Bohrung

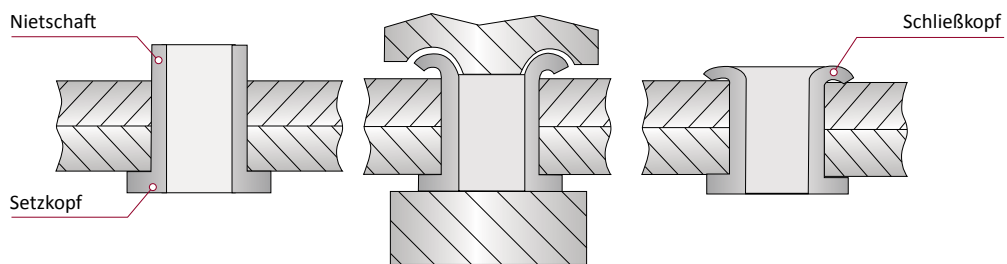

Auf Anfrage verfügbare Industrieniete

DIN 7340 B







DIN 662



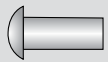

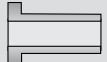

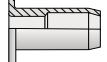

Lagerprogramm

Diese Ausführungen sind grundsätzlich in den meisten Abmessungen ab Lager **sofort verfügbar** oder kurzfristig zu produzieren. Bestände und Tagespreise nennen wir Ihnen gern.

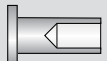
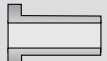
Vollniete	Halbhohniete	Hohniete
DIN 660 Halbrundkopfniete Aluminium und Stahl 	DIN 7338 B Stahl und Kupfer 	DIN 7338 C 1 Rohrniete Stahl und Kupfer 
DIN 661 Senkkopfniete Aluminium und Stahl 		Rohrniete DB-Ausführung Stahl 

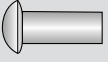
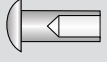
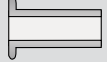

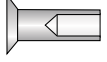



Auf Anfrage

Bei diesen Produkten fragen Sie unsere Vertriebsmitarbeiterinnen und -mitarbeiter nach eventuellen Beständen. Eine Produktion ist mit entsprechenden Mindestbestellmengen möglich.

Vollniete	Halbhohniete	Hohniete
DIN 660 Halbrundkopfniete Andere Materialien 	DIN 7338 B Andere Materialien 	DIN 7338 C 1 Rohrniete Andere Materialien 
DIN 661 Senkkopfniete Andere Materialien 		
DIN 662 Linsenniete 	DIN 6791 	DIN 7340 A 
DIN 7338 A Zylinderniete 	DIN 6792 	DIN 7340 B 

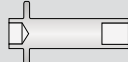
Sonderteile

Über die o.g. Produktgruppen hinaus sind eine Vielzahl von Sonderformen und -ausführungen - **zum Teil ab Lager** - verfügbar. Senden Sie uns Ihre Anfrage und wir prüfen schnell und zuverlässig Bestand oder Machbarkeit und lassen Ihnen ein entsprechendes Angebot zukommen.

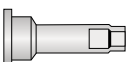
Flachsenknete MAN-Ausführung 	Belagniete 		
US-Ausführung 			

Produzierbare Größen

DIN 660	DIN 661	DIN 7338 C 1	DIN 7340
Schaft- \varnothing 1 - 12 mm	Schaft- \varnothing 2 - 10 mm	Schaft- \varnothing 3 - 10 mm	Schaft- \varnothing 0,8 - 20 mm
Schaftlängen max. 100 mm	Schaftlängen max. 60 mm	Schaftlängen max. 250 mm	Schaftlängen max. 400 mm

Alle Angaben in Abhängigkeit zum Schaftdurchmesser. Anhaltswerte für Klemmlängen und Schaftüberstände finde Sie auf der Folgeseite.



DIN 674



DIN 675

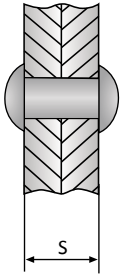

DIN 6791

DIN 660**Anhaltswerte für die Klemmlängen von Vollniete in Abhängigkeit von Schaftdurchmesser und Schließkopfform nach DIN 660.**

Form A

Halbrunder Kopf als Schließkopf

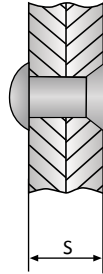

Form B

Senkkopf als Schließkopf



Nennlänge (mm)	ø 3 mm		ø 4 mm		ø 5 mm		ø 6 mm		ø 8 mm	
	A	Form B	A	Form B	A	Form B	A	Form B	A	Form B
	max. Klemmlänge (mm)		max. Klemmlänge (mm)		max. Klemmlänge (mm)		max. Klemmlänge (mm)		max. Klemmlänge (mm)	
5	1,5	3	–	2	–	1,5	–	–	–	–
6	2	4	1	3	–	2,5	–	2	–	–
8	4	5,5	3	5	2	4,5	0,5	4	–	3
10	5,5	7,5	4,5	7	4	6,5	2,5	6	–	5
12	7,5	9	6	9	5,5	8,5	4,5	8	2,5	7
14	9,5	10,5	7,5	10	7	10	6,5	9,5	4	8,5
16	11	12	9	11	9	11,5	8	11	6	10
18	13	14	11	13	11	13	9,5	13	8	12
20	14	16	13	15	12	15	11	15	9,5	14
22	16	18	15	17	14	17	13	17	11	15
25	18	20	17	19	17	19	16	19	14	18
28	21	23	20	22	19	22	18	22	16	21
30	23	25	22	24	21	24	20	23	18	22
32	–	–	23	26	23	26	22	25	20	24
35	–	–	26	28	25	28	24	28	22	27
38	–	–	29	31	28	31	27	30	25	29
40	–	–	30	32	30	32	28	32	27	31

Zur genauen Abstimmung werden **Nietversuche** empfohlen

DIN 7338 Anhaltswerte für Schaftüberstände zur Schließkopfbildung in Abhängigkeit von Schaftdurchmesser und Schaftlänge nach DIN 7338.

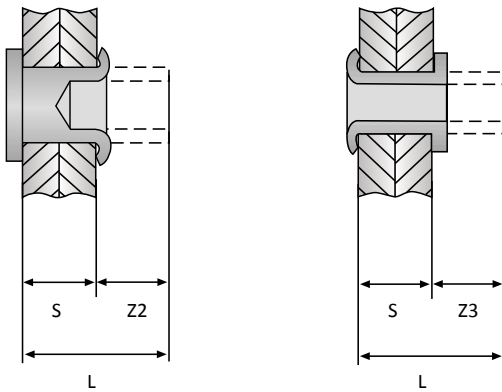

Nennlänge (mm)	Überstand Z2 (mm)	Überstand Z3 (mm)
3	ca. 2	ca. 2,5
4	ca. 2	ca. 3
5	ca. 2,5	ca. 3,5
6	bis L = 20 mm ca. 3 ab L = 22 mm ca. 3,5	ca. 4
8	bis L = 20 mm ca. 4 ab L = 22 mm ca. 4,5	ca. 4,5

Zur genauen Abstimmung werden **Nietversuche** empfohlen.





Aluminium, Stahl, Kupfer, Messing

- > Vollniet
- > Halbrundkopf

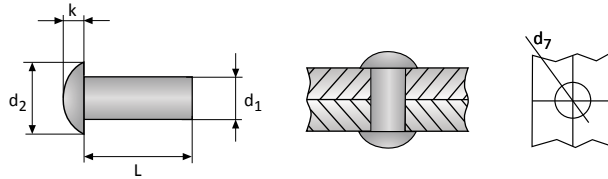

d ₁	L	Artikelnummern				
		Aluminium	Stahl	Kupfer	Messing	
3,0	5	10.003.030.050	10.000.030.050	10.001.030.050	10.002.030.050	2000
	6	10.003.030.060	10.000.030.060	10.001.030.060	10.002.030.060	2000
	8	10.003.030.080	10.000.030.080	10.001.030.080	10.002.030.080	2000
	10	10.003.030.100	10.000.030.100	10.001.030.100	10.002.030.100	2000
	12	10.003.030.120	10.000.030.120	10.001.030.120	10.002.030.120	1000
	16	10.003.030.160	10.000.030.160	10.001.030.160	10.002.030.160	1000
	20	10.003.030.200	10.000.030.200	10.001.030.200	10.002.030.200	1000
	25	10.003.030.250	10.000.030.250	10.001.030.250	10.002.030.250	1000
d₇ 3,1 +0,12 mm		d₂ 5,2 mm		k 1,8 mm		
4,0	6	10.003.040.060	10.000.040.060	10.001.040.060	10.002.040.060	1000
	8	10.003.040.080	10.000.040.080	10.001.040.080	10.002.040.080	1000
	10	10.003.040.100	10.000.040.100	10.001.040.100	10.002.040.100	1000
	12	10.003.040.120	10.000.040.120	10.001.040.120	10.002.040.120	1000
	16	10.003.040.160	10.000.040.160	10.001.040.160	10.002.040.160	1000
	18	10.003.040.180	10.000.040.180	10.001.040.180	10.002.040.180	1000
	20	10.003.040.200	10.000.040.200	10.001.040.200	10.002.040.200	1000
	22	10.003.040.220	10.000.040.220	10.001.040.220	10.002.040.220	1000
	25	10.003.040.250	10.000.040.250	10.001.040.250	10.002.040.250	1000
	30	10.003.040.300	10.000.040.300	10.001.040.300	10.002.040.300	1000
d₇ 4,2 +0,12 mm		d₂ 7,0 mm		k 2,4 mm		
5,0	6	10.003.050.060	10.000.050.060	10.001.050.060	10.002.050.060	1000
	8	10.003.050.080	10.000.050.080	10.001.050.080	10.002.050.080	1000
	10	10.003.050.100	10.000.050.100	10.001.050.100	10.002.050.100	1000
	12	10.003.050.120	10.000.050.120	10.001.050.120	10.002.050.120	1000
	16	10.003.050.160	10.000.050.160	10.001.050.160	10.002.050.160	1000
	20	10.003.050.200	10.000.050.200	10.001.050.200	10.002.050.200	1000
	25	10.003.050.250	10.000.050.250	10.001.050.250	10.002.050.250	1000
	30	10.003.050.300	10.000.050.300	10.001.050.300	10.002.050.300	500
d₇ 5,2 +0,12 mm		d₂ 8,8 mm		k 3,0 mm		
6,0	8	10.003.060.080	10.000.060.080	10.001.060.080	10.002.060.080	1000
	10	10.003.060.100	10.000.060.100	10.001.060.100	10.002.060.100	1000
	12	10.003.060.120	10.000.060.120	10.001.060.120	10.002.060.120	500
	16	10.003.060.160	10.000.060.160	10.001.060.160	10.002.060.160	500
	20	10.003.060.200	10.000.060.200	10.001.060.200	10.002.060.200	500
	25	10.003.060.250	10.000.060.250	10.001.060.250	10.002.060.250	500
	30	10.003.060.300	10.000.060.300	10.001.060.300	10.002.060.300	250
d₇ 6,3 +0,15 mm		d₂ 10,5 mm		k 3,6 mm		

Auf Anfrage weitere ...

>> Längen, >> Zwischengrößen, >> Schaftdurchmesser 8 mm, >> Schaftdurchmesser 10-16 mm (nach DIN 124), >> spezielle Oberflächen

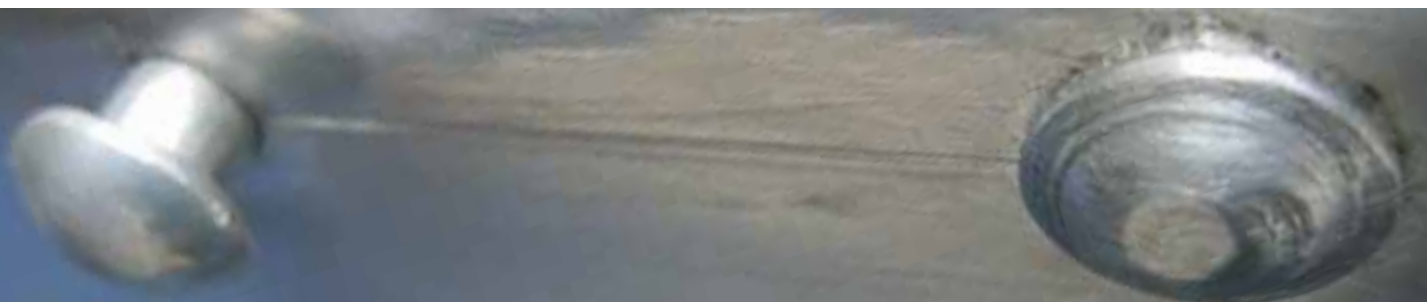



Aluminium, Stahl, Kupfer, Messing

Vollniet <
Senkkopf <

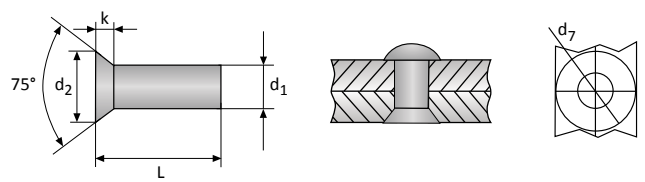

d ₁	L	Artikelnummern				
		Aluminium	Stahl	Kupfer	Messing	
3,0	5	10.023.030.050	10.020.030.050	10.021.030.050	10.022.030.050	2000
	6	10.023.030.060	10.020.030.060	10.021.030.060	10.022.030.060	2000
	8	10.023.030.080	10.020.030.080	10.021.030.080	10.022.030.080	2000
	10	10.023.030.100	10.020.030.100	10.021.030.100	10.022.030.100	2000
	12	10.023.030.120	10.020.030.120	10.021.030.120	10.022.030.120	1000
	16	10.023.030.160	10.020.030.160	10.021.030.160	10.022.030.160	1000
	20	10.023.030.200	10.020.030.200	10.021.030.200	10.022.030.200	1000
	25	10.023.030.250	10.020.030.250	10.021.030.250	10.022.030.250	1000
d ₇ 3,1 +0,12 mm		d ₂ 5,2 mm		k 1,4 mm		
4,0	6	10.023.040.060	10.020.040.060	10.021.040.060	10.022.040.060	1000
	8	10.023.040.080	10.020.040.080	10.021.040.080	10.022.040.080	1000
	10	10.023.040.100	10.020.040.100	10.021.040.100	10.022.040.100	1000
	12	10.023.040.120	10.020.040.120	10.021.040.120	10.022.040.120	1000
	16	10.023.040.160	10.020.040.160	10.021.040.160	10.022.040.160	1000
	18	10.023.040.180	10.020.040.180	10.021.040.180	10.022.040.180	1000
	20	10.023.040.200	10.020.040.200	10.021.040.200	10.022.040.200	1000
	22	10.023.040.220	10.020.040.220	10.021.040.220	10.022.040.220	1000
	25	10.023.040.250	10.020.040.250	10.021.040.250	10.022.040.250	1000
	30	10.023.040.300	10.020.040.300	10.021.040.300	10.022.040.300	1000
d ₇ 4,2 +0,12 mm		d ₂ 7,0 mm		k 2,0 mm		
5,0	6	10.023.050.060	10.020.050.060	10.021.050.060	10.022.050.060	1000
	8	10.023.050.080	10.020.050.080	10.021.050.080	10.022.050.080	1000
	10	10.023.050.100	10.020.050.100	10.021.050.100	10.022.050.100	1000
	12	10.023.050.120	10.020.050.120	10.021.050.120	10.022.050.120	1000
	16	10.023.050.160	10.020.050.160	10.021.050.160	10.022.050.160	1000
	20	10.023.050.200	10.020.050.200	10.021.050.200	10.022.050.200	1000
	25	10.023.050.250	10.020.050.250	10.021.050.250	10.022.050.250	1000
d ₇ 5,2 +0,12 mm		d ₂ 8,8 mm		k 2,5 mm		
6,0	8	10.023.060.080	10.020.060.080	10.021.060.080	10.022.060.080	1000
	10	10.023.060.100	10.020.060.100	10.021.060.100	10.022.060.100	1000
	12	10.023.060.120	10.020.060.120	10.021.060.120	10.022.060.120	500
	16	10.023.060.160	10.020.060.160	10.021.060.160	10.022.060.160	500
	20	10.023.060.200	10.020.060.200	10.021.060.200	10.022.060.200	500
	22	10.023.060.220	10.020.060.220	10.021.060.220	10.022.060.220	500
	25	10.023.060.250	10.020.060.250	10.021.060.250	10.022.060.250	250
	28	10.023.060.280	10.020.060.280	10.021.060.280	10.022.060.280	250
d ₇ 6,3 +0,15 mm		d ₂ 10,5 mm		k 3,0 mm		

DIN 661





Aluminium, Stahl, Kupfer, Messing

- > Halbhohlriet
- > Zylinderkopf

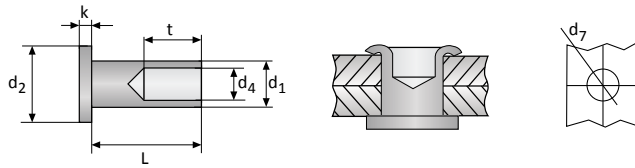

d ₁	L	Artikelnummern				
		Aluminium	Stahl	Kupfer	Messing	
3,0	4	10.163.030.040	10.160.030.040	10.161.030.040	10.162.030.040	1000
	5	10.163.030.050	10.160.030.050	10.161.030.050	10.162.030.050	1000
	6	10.163.030.060	10.160.030.060	10.161.030.060	10.162.030.060	1000
	8	10.163.030.080	10.160.030.080	10.161.030.080	10.162.030.080	1000
	10	10.163.030.100	10.160.030.100	10.161.030.100	10.162.030.100	1000
	12	10.163.030.120	10.160.030.120	10.161.030.120	10.162.030.120	1000
	18	10.163.030.180	10.160.030.180	10.161.030.180	10.162.030.180	1000
d ₇ 3,1 +0,12 mm		d ₄ 1,7	d ₂ 5,5 mm	k 0,8 mm	t 4,0 mm	
4,0	6*	10.163.040.060	10.160.040.060	10.161.040.060	10.162.040.060	1000
	8	10.163.040.080	10.160.040.080	10.161.040.080	10.162.040.080	1000
	10	10.163.040.100	10.160.040.100	10.161.040.100	10.162.040.100	1000
	12	10.163.040.120	10.160.040.120	10.161.040.120	10.162.040.120	1000
	15	10.163.040.150	10.160.040.150	10.161.040.150	10.162.040.150	1000
d ₇ 4,2 +0,12 mm		d ₄ 2,7	d ₂ 7,5 mm	k 1,0 mm	t 5,0 mm (*4,0 mm)	
5,0	8*	10.163.050.080	10.160.050.080	10.161.050.080	10.162.050.080	1000
	10	10.163.050.100	10.160.050.100	10.161.050.100	10.162.050.100	1000
	12	10.163.050.120	10.160.050.120	10.161.050.120	10.162.050.120	1000
	15	10.163.050.150	10.160.050.150	10.161.050.150	10.162.050.150	1000
	18	10.163.050.180	10.160.050.180	10.161.050.180	10.162.050.180	1000
	20	10.163.050.200	10.160.050.200	10.161.050.200	10.162.050.200	1000
d ₇ 5,2 +0,12 mm		d ₄ 3,5	d ₂ 9,5 mm	k 1,0 mm	t 6,0 mm (*4,0 mm)	
6,0	10	10.163.060.100	10.160.060.100	10.161.060.100	10.162.060.100	1000
	12	10.163.060.120	10.160.060.120	10.161.060.120	10.162.060.120	1000
	15	10.163.060.150	10.160.060.150	10.161.060.150	10.162.060.150	1000
	18	10.163.060.180	10.160.060.180	10.161.060.180	10.162.060.180	1000
	20	10.163.060.200	10.160.060.200	10.161.060.200	10.162.060.200	1000
	22	10.163.060.220	10.160.060.220	10.161.060.220	10.162.060.220	1000
	25	10.163.060.250	10.160.060.250	10.161.060.250	10.162.060.250	1000
	30	10.163.060.300	10.160.060.300	10.161.060.300	10.162.060.300	1000
d ₇ 6,3 +0,15 mm		d ₄ 4,2	d ₂ 11,5 mm	k 1,2 mm	t 8,0 mm	
8,0	12	10.163.080.120	10.160.080.120	10.161.080.120	10.162.080.120	1000
	15	10.163.080.150	10.160.080.150	10.161.080.150	10.162.080.150	1000
	18	10.163.080.180	10.160.080.180	10.161.080.180	10.162.080.180	1000
	20	10.163.080.200	10.160.080.200	10.161.080.200	10.162.080.200	1000
	22	10.163.080.220	10.160.080.220	10.161.080.220	10.162.080.220	1000
	25	10.163.080.250	10.160.080.250	10.161.080.250	10.162.080.250	1000
d ₇ 8,4 +0,15 mm		d ₄ 6,0	d ₂ 15,5 mm	k 1,2 mm	t 10,0 mm	
10,0	16	10.163.100.160	10.160.100.160	10.161.100.160	10.162.100.160	1000
	18	10.163.100.180	10.160.100.180	10.161.100.180	10.162.100.180	1000
	20	10.163.100.200	10.160.100.200	10.161.100.200	10.162.100.200	1000
	22	10.163.100.220	10.160.100.220	10.161.100.220	10.162.100.220	1000
	25	10.163.100.250	10.160.100.250	10.161.100.250	10.162.100.250	1000
d ₇ 10,5 +0,15 mm		d ₄ 7,5	d ₂ 18,0 mm	k 1,2 mm	t 12,0 mm	

► Anhaltswerte für Klemmlängen und Schaftüberstände finden Sie auf den [Seiten 130/131](#).

! Verpackt in Beuteln zu 100 Stück.



Aluminium, Stahl, Kupfer, Messing

Rohrriet <
Zylinderkopf <

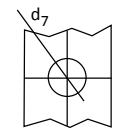
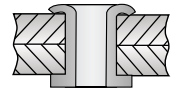
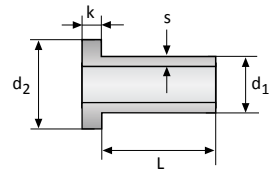

d ₁	L	Artikelnummern				
		Aluminium	Stahl	Kupfer	Messing	
3,0	6	10.183.030.060	10.180.030.060	10.181.030.060	10.182.030.060	1000
	8	10.183.030.080	10.180.030.080	10.181.030.080	10.182.030.080	1000
	10	10.183.030.100	10.180.030.100	10.181.030.100	10.182.030.100	1000
	12	10.183.030.120	10.180.030.120	10.181.030.120	10.182.030.120	1000
d ₇ 3,1 +0,12 mm		s 0,5	d ₂ 5,5 mm		k 0,8 mm	
4,0	6	10.183.040.060	10.180.040.060	10.181.040.060	10.182.040.060	1000
	8	10.183.040.080	10.180.040.080	10.181.040.080	10.182.040.080	1000
	10	10.183.040.100	10.180.040.100	10.181.040.100	10.182.040.100	1000
	12	10.183.040.120	10.180.040.120	10.181.040.120	10.182.040.120	1000
	15	10.183.040.150	10.180.040.150	10.181.040.150	10.182.040.150	1000
d ₇ 4,2 +0,12 mm		s 0,5	d ₂ 7,5 mm		k 1,0 mm	
5,0	8	10.183.050.080	10.180.050.080	10.181.050.080	10.182.050.080	1000
	10	10.183.050.100	10.180.050.100	10.181.050.100	10.182.050.100	1000
	12	10.183.050.120	10.180.050.120	10.181.050.120	10.182.050.120	1000
	15	10.183.050.150	10.180.050.150	10.181.050.150	10.182.050.150	1000
d ₇ 5,1 +0,12 mm		s 0,5	d ₂ 9,5 mm		k 1,0 mm	
6,0	10	10.183.060.100	10.180.060.100	10.181.060.100	10.182.060.100	1000
	12	10.183.060.120	10.180.060.120	10.181.060.120	10.182.060.120	1000
	15	10.183.060.150	10.180.060.150	10.181.060.150	10.182.060.150	1000
	18	10.183.060.180	10.180.060.180	10.181.060.180	10.182.060.180	1000
	20	10.183.060.200	10.180.060.200	10.181.060.200	10.182.060.200	1000
	25	10.183.060.250	10.180.060.250	10.181.060.250	10.182.060.250	1000
d ₇ 6,1 +0,15 mm		s 0,75	d ₂ 11,5 mm		k 1,2 mm	
8,0	12	10.183.080.120	10.180.080.120	10.181.080.120	10.182.080.120	1000
	15	10.183.080.150	10.180.080.150	10.181.080.150	10.182.080.150	1000
	18	10.183.080.180	10.180.080.180	10.181.080.180	10.182.080.180	1000
	20	10.183.080.200	10.180.080.200	10.181.080.200	10.182.080.200	1000
	22	10.183.080.220	10.180.080.220	10.181.080.220	10.182.080.220	1000
	25	10.183.080.250	10.180.080.250	10.181.080.250	10.182.080.250	1000
d ₇ 8,4 +0,15 mm		s 1,2	d ₂ 15,5 mm		k 1,2 mm	
10,0	15	10.183.100.150	10.180.100.150	10.181.100.150	10.182.100.150	1000
	18	10.183.100.180	10.180.100.180	10.181.100.180	10.182.100.180	1000
	20	10.183.100.200	10.180.100.200	10.181.100.200	10.182.100.200	1000
d ₇ 10,5 +0,15 mm		s 1,2	d ₂ 18,0 mm		k 1,2 mm	

! Verpackt in Beuteln zu 100 Stück.



DIN 7338 C1