





**i** "Industrial rivets according to DIN" are the **classical one-piece type of rivets** that are handled **both-sided** of the component.

The connection is realised by forming the shank with axial pressure on its end. The production of all types mentioned on page ► 129 is possible from aluminium, steel, copper, brass and stainless steel in general.

VVG carries a comprehensive stock range.

Please ask our sales team for current prices/availabilities or possibilities of production and individual fabrications.

There are basically three different types of industrial rivets according to DIN:

### SOLID RIVETS - Rivets with solid shank

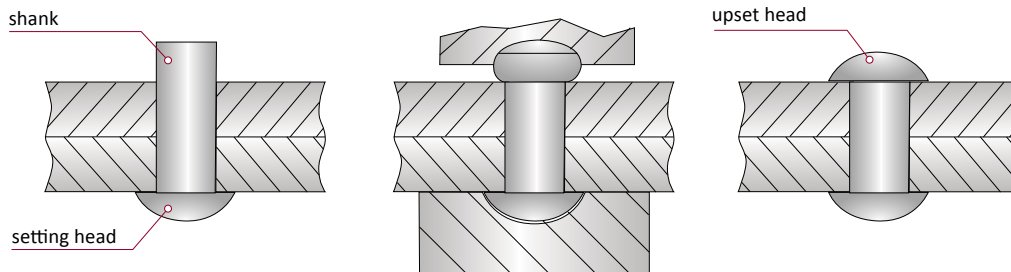

### SEMI-TUBULAR RIVETS - shank with partial bore hole

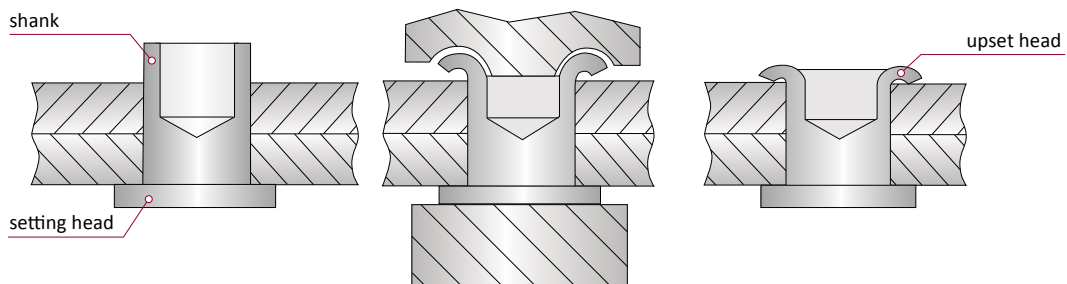

### TUBULAR RIVETS - shank with persistent bore hole

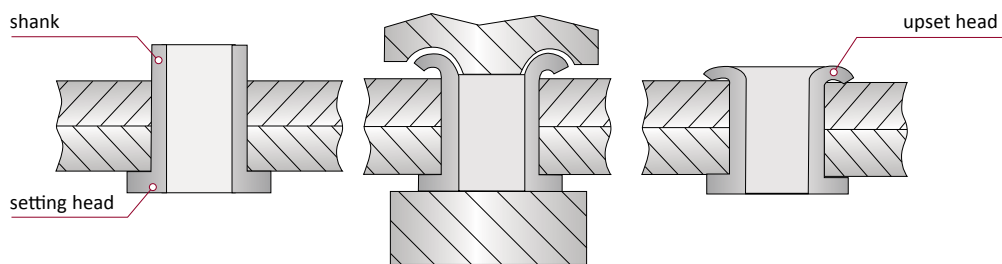

Available on Request

DIN 7340 B







DIN 662



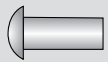

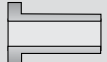

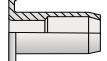

## From Stock

Most dimensions of these versions are **available from stock** or reproducible within short terms in general. Please ask for inventory and current prices.

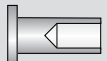
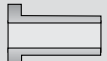
Solid Rivets	Semi-Tubular Rivets	Tubular Rivets
DIN 660 Round head rivet Aluminium and steel 	DIN 7338 B Steel and copper 	DIN 7338 C 1 Tubular Rivet Steel and copper 
DIN 661 Countersunk rivet Aluminium and steel 		Tubular rivet DB-type Steel 

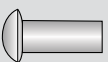
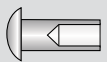
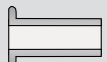



## On Request

Contact our sales team for possible stocks. If minimum order quantities are reached, we can manufacture these products.

Solid Rivets	Semi-Tubular Rivets	Tubular Rivets
DIN 660 Round head rivet Other materials 	DIN 7338 B Other materials 	DIN 7338 C 1 Rohrniete Other materials 
DIN 661 Countersunk rivet Other materials 		
DIN 662 Raised head rivet 	DIN 6791 	DIN 7340 A 
DIN 7338 A Cylinder head rivet 	DIN 6792 	DIN 7340 B 

## Special Parts

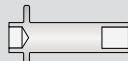
In addition to the mentioned product groups a multitude of special forms and types are available - **partly from stock**. Please send your inquiry and we will check immediately the warehouse stock, the producibility or possibilities for alternatives and prepare a suitable offer.

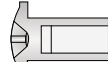
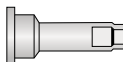
Flat countersunk rivet MAN-type 	Covering rivet 		
Flat countersunk rivet US-type 			

<b>!</b> <b>Producible sizes</b>					
<b>DIN 660</b>	<b>DIN 661</b>	<b>DIN 7338 C 1</b>	<b>DIN 7340</b>		
Shank- $\varnothing$ 1 - 12 mm	Shank- $\varnothing$ 2 - 10 mm	Shank- $\varnothing$ 3 - 10 mm	Shank- $\varnothing$ 0,8 - 20 mm		
Max. length of shank 100 mm	Max. length of shank 60 mm	Max. length of shank 250 mm	Max. length of shank 400 mm		

Information about grip ranges and excess lengths of the shank on the next page.



DIN 674



DIN 675



DIN 6791

**DIN 660**

Reference values for grip ranges of solid rivets subject to the diameter of the shank and type of the upset-head according to DIN 660.

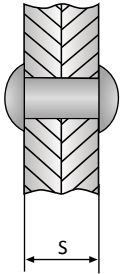

Type A

Round head as upset-head

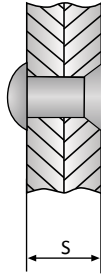

Type B

Countersunk head as upset-head



Nominal length (mm)	ø 3 mm		ø 4 mm		ø 5 mm		ø 6 mm		ø 8 mm	
	A	Type B	A	Type B	A	Type B	A	Type B	A	Type B
	max. grip range (mm)		max. grip range (mm)		max. grip range (mm)		max. grip range (mm)		max. grip range (mm)	
5	1,5	3	–	2	–	1,5	–	–	–	–
6	2	4	1	3	–	2,5	–	2	–	–
8	4	5,5	3	5	2	4,5	0,5	4	–	3
10	5,5	7,5	4,5	7	4	6,5	2,5	6	–	5
12	7,5	9	6	9	5,5	8,5	4,5	8	2,5	7
14	9,5	10,5	7,5	10	7	10	6,5	9,5	4	8,5
16	11	12	9	11	9	11,5	8	11	6	10
18	13	14	11	13	11	13	9,5	13	8	12
20	14	16	13	15	12	15	11	15	9,5	14
22	16	18	15	17	14	17	13	17	11	15
25	18	20	17	19	17	19	16	19	14	18
28	21	23	20	22	19	22	18	22	16	21
30	23	25	22	24	21	24	20	23	18	22
32	–	–	23	26	23	26	22	25	20	24
35	–	–	26	28	25	28	24	28	22	27
38	–	–	29	31	28	31	27	30	25	29
40	–	–	30	32	30	32	28	32	27	31

Individual tests recommended!



**DIN 7338** Reference values for the excess length of the shaft for forming the upset-head subject to the diameter and length of the shaft according to DIN 7338.

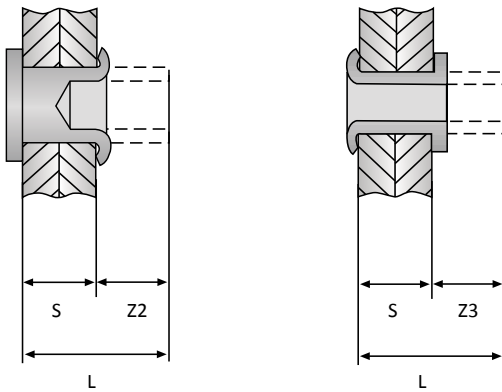

Nominal diameter (mm)	Excess length Z2 (mm)	Excess length Z3 (mm)
3	approx. 2	approx. 2,5
4	approx. 2	approx. 3
5	approx. 2,5	approx. 3,5
6	up to L = 20 mm approx. 3 from L = 22 mm approx. 3,5	approx. 4
8	up to L = 20 mm approx. 4 from L = 22 mm approx. 4,5	approx. 4,5

Individual tests recommended!





**Aluminium, Steel, Copper, Brass**

- > Solid Rivet
- > Round Head

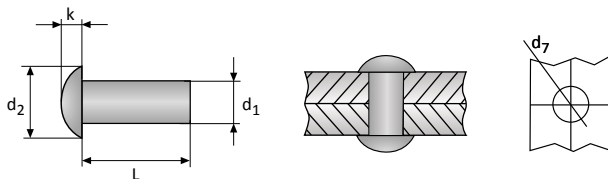

d <sub>1</sub>	L	Article numbers				
		Aluminium	Steel	Copper	Brass	
<b>3,0</b>	5	10.003.030.050	10.000.030.050	10.001.030.050	10.002.030.050	2000
	6	10.003.030.060	10.000.030.060	10.001.030.060	10.002.030.060	2000
	8	10.003.030.080	10.000.030.080	10.001.030.080	10.002.030.080	2000
	10	10.003.030.100	10.000.030.100	10.001.030.100	10.002.030.100	2000
	12	10.003.030.120	10.000.030.120	10.001.030.120	10.002.030.120	1000
	16	10.003.030.160	10.000.030.160	10.001.030.160	10.002.030.160	1000
	20	10.003.030.200	10.000.030.200	10.001.030.200	10.002.030.200	1000
	25	10.003.030.250	10.000.030.250	10.001.030.250	10.002.030.250	1000
<b>d<sub>7</sub> 3,1 +0,12 mm</b>		<b>d<sub>2</sub> 5,2 mm</b>		<b>k 1,8 mm</b>		
<b>4,0</b>	6	10.003.040.060	10.000.040.060	10.001.040.060	10.002.040.060	1000
	8	10.003.040.080	10.000.040.080	10.001.040.080	10.002.040.080	1000
	10	10.003.040.100	10.000.040.100	10.001.040.100	10.002.040.100	1000
	12	10.003.040.120	10.000.040.120	10.001.040.120	10.002.040.120	1000
	16	10.003.040.160	10.000.040.160	10.001.040.160	10.002.040.160	1000
	18	10.003.040.180	10.000.040.180	10.001.040.180	10.002.040.180	1000
	20	10.003.040.200	10.000.040.200	10.001.040.200	10.002.040.200	1000
	22	10.003.040.220	10.000.040.220	10.001.040.220	10.002.040.220	1000
	25	10.003.040.250	10.000.040.250	10.001.040.250	10.002.040.250	1000
	30	10.003.040.300	10.000.040.300	10.001.040.300	10.002.040.300	1000
<b>d<sub>7</sub> 4,2 +0,12 mm</b>		<b>d<sub>2</sub> 7,0 mm</b>		<b>k 2,4 mm</b>		
<b>5,0</b>	6	10.003.050.060	10.000.050.060	10.001.050.060	10.002.050.060	1000
	8	10.003.050.080	10.000.050.080	10.001.050.080	10.002.050.080	1000
	10	10.003.050.100	10.000.050.100	10.001.050.100	10.002.050.100	1000
	12	10.003.050.120	10.000.050.120	10.001.050.120	10.002.050.120	1000
	16	10.003.050.160	10.000.050.160	10.001.050.160	10.002.050.160	1000
	20	10.003.050.200	10.000.050.200	10.001.050.200	10.002.050.200	1000
	25	10.003.050.250	10.000.050.250	10.001.050.250	10.002.050.250	1000
	30	10.003.050.300	10.000.050.300	10.001.050.300	10.002.050.300	500
<b>d<sub>7</sub> 5,2 +0,12 mm</b>		<b>d<sub>2</sub> 8,8 mm</b>		<b>k 3,0 mm</b>		
<b>6,0</b>	8	10.003.060.080	10.000.060.080	10.001.060.080	10.002.060.080	1000
	10	10.003.060.100	10.000.060.100	10.001.060.100	10.002.060.100	1000
	12	10.003.060.120	10.000.060.120	10.001.060.120	10.002.060.120	500
	16	10.003.060.160	10.000.060.160	10.001.060.160	10.002.060.160	500
	20	10.003.060.200	10.000.060.200	10.001.060.200	10.002.060.200	500
	25	10.003.060.250	10.000.060.250	10.001.060.250	10.002.060.250	500
	30	10.003.060.300	10.000.060.300	10.001.060.300	10.002.060.300	250
<b>d<sub>7</sub> 6,3 +0,15 mm</b>		<b>d<sub>2</sub> 10,5 mm</b>		<b>k 3,6 mm</b>		

On request further ...

>> lengths, >> intermedia sizes, >> shank diameter 8 mm, >> shank diameter 10-16 mm (according to DIN 124), >> special surface treat-

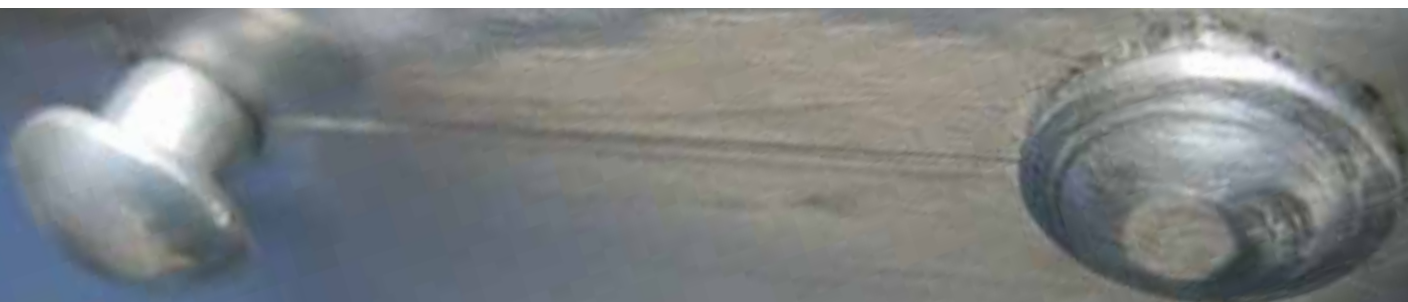



Aluminium, Steel, Copper, Brass

Solid Rivet <  
Countersunk Head <

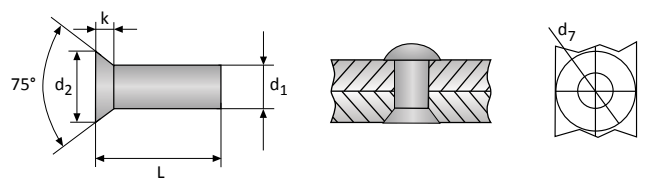

d <sub>1</sub>	L	Article numbers				
		Aluminium	Steel	Copper	Brass	
<b>3,0</b>	5	10.023.030.050	10.020.030.050	10.021.030.050	10.022.030.050	2000
	6	10.023.030.060	10.020.030.060	10.021.030.060	10.022.030.060	2000
	8	10.023.030.080	10.020.030.080	10.021.030.080	10.022.030.080	2000
	10	10.023.030.100	10.020.030.100	10.021.030.100	10.022.030.100	2000
	12	10.023.030.120	10.020.030.120	10.021.030.120	10.022.030.120	1000
	16	10.023.030.160	10.020.030.160	10.021.030.160	10.022.030.160	1000
	20	10.023.030.200	10.020.030.200	10.021.030.200	10.022.030.200	1000
	25	10.023.030.250	10.020.030.250	10.021.030.250	10.022.030.250	1000
<b>d<sub>7</sub> 3,1 +0,12 mm</b>		<b>d<sub>2</sub> 5,2 mm</b>		<b>k 1,4 mm</b>		
<b>4,0</b>	6	10.023.040.060	10.020.040.060	10.021.040.060	10.022.040.060	1000
	8	10.023.040.080	10.020.040.080	10.021.040.080	10.022.040.080	1000
	10	10.023.040.100	10.020.040.100	10.021.040.100	10.022.040.100	1000
	12	10.023.040.120	10.020.040.120	10.021.040.120	10.022.040.120	1000
	16	10.023.040.160	10.020.040.160	10.021.040.160	10.022.040.160	1000
	18	10.023.040.180	10.020.040.180	10.021.040.180	10.022.040.180	1000
	20	10.023.040.200	10.020.040.200	10.021.040.200	10.022.040.200	1000
	22	10.023.040.220	10.020.040.220	10.021.040.220	10.022.040.220	1000
	25	10.023.040.250	10.020.040.250	10.021.040.250	10.022.040.250	1000
	30	10.023.040.300	10.020.040.300	10.021.040.300	10.022.040.300	1000
<b>d<sub>7</sub> 4,2 +0,12 mm</b>		<b>d<sub>2</sub> 7,0 mm</b>		<b>k 2,0 mm</b>		
<b>5,0</b>	6	10.023.050.060	10.020.050.060	10.021.050.060	10.022.050.060	1000
	8	10.023.050.080	10.020.050.080	10.021.050.080	10.022.050.080	1000
	10	10.023.050.100	10.020.050.100	10.021.050.100	10.022.050.100	1000
	12	10.023.050.120	10.020.050.120	10.021.050.120	10.022.050.120	1000
	16	10.023.050.160	10.020.050.160	10.021.050.160	10.022.050.160	1000
	20	10.023.050.200	10.020.050.200	10.021.050.200	10.022.050.200	1000
	25	10.023.050.250	10.020.050.250	10.021.050.250	10.022.050.250	1000
<b>d<sub>7</sub> 5,2 +0,12 mm</b>		<b>d<sub>2</sub> 8,8 mm</b>		<b>k 2,5 mm</b>		
<b>6,0</b>	8	10.023.060.080	10.020.060.080	10.021.060.080	10.022.060.080	1000
	10	10.023.060.100	10.020.060.100	10.021.060.100	10.022.060.100	1000
	12	10.023.060.120	10.020.060.120	10.021.060.120	10.022.060.120	500
	16	10.023.060.160	10.020.060.160	10.021.060.160	10.022.060.160	500
	20	10.023.060.200	10.020.060.200	10.021.060.200	10.022.060.200	500
	22	10.023.060.220	10.020.060.220	10.021.060.220	10.022.060.220	500
	25	10.023.060.250	10.020.060.250	10.021.060.250	10.022.060.250	250
	28	10.023.060.280	10.020.060.280	10.021.060.280	10.022.060.280	250
<b>d<sub>7</sub> 6,3 +0,15 mm</b>		<b>d<sub>2</sub> 10,5 mm</b>		<b>k 3,0 mm</b>		

DIN 661







**Aluminium, Steel, Copper, Brass**

- > Semi-Tubular Rivet
- > Cylinder Head

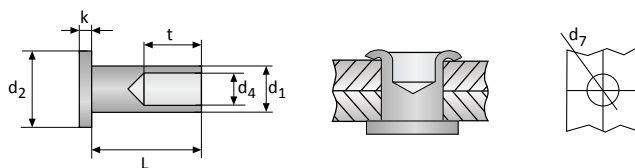

d <sub>1</sub>	L	Article numbers				
		Aluminium	Steel	Copper	Brass	
<b>3,0</b>	4	10.163.030.040	10.160.030.040	10.161.030.040	10.162.030.040	1000
	5	10.163.030.050	10.160.030.050	10.161.030.050	10.162.030.050	1000
	6	10.163.030.060	10.160.030.060	10.161.030.060	10.162.030.060	1000
	8	10.163.030.080	10.160.030.080	10.161.030.080	10.162.030.080	1000
	10	10.163.030.100	10.160.030.100	10.161.030.100	10.162.030.100	1000
	12	10.163.030.120	10.160.030.120	10.161.030.120	10.162.030.120	1000
	18	10.163.030.180	10.160.030.180	10.161.030.180	10.162.030.180	1000
<b>d<sub>7</sub> 3,1 +0,12 mm</b>		<b>d<sub>4</sub> 1,7</b>	<b>d<sub>2</sub> 5,5 mm</b>	<b>k 0,8 mm</b>	<b>t 4,0 mm</b>	
<b>4,0</b>	6*	10.163.040.060	10.160.040.060	10.161.040.060	10.162.040.060	1000
	8	10.163.040.080	10.160.040.080	10.161.040.080	10.162.040.080	1000
	10	10.163.040.100	10.160.040.100	10.161.040.100	10.162.040.100	1000
	12	10.163.040.120	10.160.040.120	10.161.040.120	10.162.040.120	1000
	15	10.163.040.150	10.160.040.150	10.161.040.150	10.162.040.150	1000
<b>d<sub>7</sub> 4,2 +0,12 mm</b>		<b>d<sub>4</sub> 2,7</b>	<b>d<sub>2</sub> 7,5 mm</b>	<b>k 1,0 mm</b>	<b>t 5,0 mm (*4,0 mm)</b>	
<b>5,0</b>	8*	10.163.050.080	10.160.050.080	10.161.050.080	10.162.050.080	1000
	10	10.163.050.100	10.160.050.100	10.161.050.100	10.162.050.100	1000
	12	10.163.050.120	10.160.050.120	10.161.050.120	10.162.050.120	1000
	15	10.163.050.150	10.160.050.150	10.161.050.150	10.162.050.150	1000
	18	10.163.050.180	10.160.050.180	10.161.050.180	10.162.050.180	1000
	20	10.163.050.200	10.160.050.200	10.161.050.200	10.162.050.200	1000
<b>d<sub>7</sub> 5,2 +0,12 mm</b>		<b>d<sub>4</sub> 3,5</b>	<b>d<sub>2</sub> 9,5 mm</b>	<b>k 1,0 mm</b>	<b>t 6,0 mm (*4,0 mm)</b>	
<b>6,0</b>	10	10.163.060.100	10.160.060.100	10.161.060.100	10.162.060.100	1000
	12	10.163.060.120	10.160.060.120	10.161.060.120	10.162.060.120	1000
	15	10.163.060.150	10.160.060.150	10.161.060.150	10.162.060.150	1000
	18	10.163.060.180	10.160.060.180	10.161.060.180	10.162.060.180	1000
	20	10.163.060.200	10.160.060.200	10.161.060.200	10.162.060.200	1000
	22	10.163.060.220	10.160.060.220	10.161.060.220	10.162.060.220	1000
	25	10.163.060.250	10.160.060.250	10.161.060.250	10.162.060.250	1000
	30	10.163.060.300	10.160.060.300	10.161.060.300	10.162.060.300	1000
<b>d<sub>7</sub> 6,3 +0,15 mm</b>		<b>d<sub>4</sub> 4,2</b>	<b>d<sub>2</sub> 11,5 mm</b>	<b>k 1,2 mm</b>	<b>t 8,0 mm</b>	
<b>8,0</b>	12	10.163.080.120	10.160.080.120	10.161.080.120	10.162.080.120	1000
	15	10.163.080.150	10.160.080.150	10.161.080.150	10.162.080.150	1000
	18	10.163.080.180	10.160.080.180	10.161.080.180	10.162.080.180	1000
	20	10.163.080.200	10.160.080.200	10.161.080.200	10.162.080.200	1000
	22	10.163.080.220	10.160.080.220	10.161.080.220	10.162.080.220	1000
	25	10.163.080.250	10.160.080.250	10.161.080.250	10.162.080.250	1000
<b>d<sub>7</sub> 8,4 +0,15 mm</b>		<b>d<sub>4</sub> 6,0</b>	<b>d<sub>2</sub> 15,5 mm</b>	<b>k 1,2 mm</b>	<b>t 10,0 mm</b>	
<b>10,0</b>	16	10.163.100.160	10.160.100.160	10.161.100.160	10.162.100.160	1000
	18	10.163.100.180	10.160.100.180	10.161.100.180	10.162.100.180	1000
	20	10.163.100.200	10.160.100.200	10.161.100.200	10.162.100.200	1000
	22	10.163.100.220	10.160.100.220	10.161.100.220	10.162.100.220	1000
	25	10.163.100.250	10.160.100.250	10.161.100.250	10.162.100.250	1000
<b>d<sub>7</sub> 10,5 +0,15 mm</b>		<b>d<sub>4</sub> 7,5</b>	<b>d<sub>2</sub> 18,0 mm</b>	<b>k 1,2 mm</b>	<b>t 12,0 mm</b>	

▶ Reference values for grip ranges and shaft overlaps on [pages 130/131](#).

▶ Packed in bags of 100 pcs.

# Industrial Rivet DIN 7338 C 1

## Series 10.180/181/182/183

Aluminium, Steel, Copper, Brass

Tubular Rivet <  
Cylinder Head <

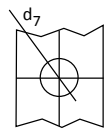
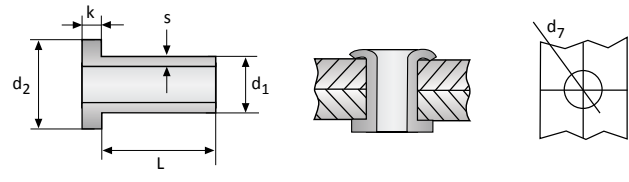

d <sub>1</sub>	L	Article numbers				
		Aluminium	Steel	Copper	Brass	
<b>3,0</b>	6	10.183.030.060	10.180.030.060	10.181.030.060	10.182.030.060	1000
	8	10.183.030.080	10.180.030.080	10.181.030.080	10.182.030.080	1000
	10	10.183.030.100	10.180.030.100	10.181.030.100	10.182.030.100	1000
	12	10.183.030.120	10.180.030.120	10.181.030.120	10.182.030.120	1000
d <sub>7</sub> 3,1 +0,12 mm		s 0,5	d <sub>2</sub> 5,5 mm		k 0,8 mm	
<b>4,0</b>	6	10.183.040.060	10.180.040.060	10.181.040.060	10.182.040.060	1000
	8	10.183.040.080	10.180.040.080	10.181.040.080	10.182.040.080	1000
	10	10.183.040.100	10.180.040.100	10.181.040.100	10.182.040.100	1000
	12	10.183.040.120	10.180.040.120	10.181.040.120	10.182.040.120	1000
	15	10.183.040.150	10.180.040.150	10.181.040.150	10.182.040.150	1000
d <sub>7</sub> 4,2 +0,12 mm		s 0,5	d <sub>2</sub> 7,5 mm		k 1,0 mm	
<b>5,0</b>	8	10.183.050.080	10.180.050.080	10.181.050.080	10.182.050.080	1000
	10	10.183.050.100	10.180.050.100	10.181.050.100	10.182.050.100	1000
	12	10.183.050.120	10.180.050.120	10.181.050.120	10.182.050.120	1000
	15	10.183.050.150	10.180.050.150	10.181.050.150	10.182.050.150	1000
d <sub>7</sub> 5,1 +0,12 mm		s 0,5	d <sub>2</sub> 9,5 mm		k 1,0 mm	
<b>6,0</b>	10	10.183.060.100	10.180.060.100	10.181.060.100	10.182.060.100	1000
	12	10.183.060.120	10.180.060.120	10.181.060.120	10.182.060.120	1000
	15	10.183.060.150	10.180.060.150	10.181.060.150	10.182.060.150	1000
	18	10.183.060.180	10.180.060.180	10.181.060.180	10.182.060.180	1000
	20	10.183.060.200	10.180.060.200	10.181.060.200	10.182.060.200	1000
	25	10.183.060.250	10.180.060.250	10.181.060.250	10.182.060.250	1000
d <sub>7</sub> 6,1 +0,15 mm		s 0,75	d <sub>2</sub> 11,5 mm		k 1,2 mm	
<b>8,0</b>	12	10.183.080.120	10.180.080.120	10.181.080.120	10.182.080.120	1000
	15	10.183.080.150	10.180.080.150	10.181.080.150	10.182.080.150	1000
	18	10.183.080.180	10.180.080.180	10.181.080.180	10.182.080.180	1000
	20	10.183.080.200	10.180.080.200	10.181.080.200	10.182.080.200	1000
	22	10.183.080.220	10.180.080.220	10.181.080.220	10.182.080.220	1000
	25	10.183.080.250	10.180.080.250	10.181.080.250	10.182.080.250	1000
d <sub>7</sub> 8,4 +0,15 mm		s 1,2	d <sub>2</sub> 15,5 mm		k 1,2 mm	
<b>10,0</b>	15	10.183.100.150	10.180.100.150	10.181.100.150	10.182.100.150	1000
	18	10.183.100.180	10.180.100.180	10.181.100.180	10.182.100.180	1000
	20	10.183.100.200	10.180.100.200	10.181.100.200	10.182.100.200	1000
d <sub>7</sub> 10,5 +0,15 mm		s 1,2	d <sub>2</sub> 18,0 mm		k 1,2 mm	

Packed in bags of 100 pcs.



DIN 7338 C1